

Port Fittings

	20324030 1/4" Hose Barb Straight							
	20325030 3/8" Hose Barb Straight	20325031 3/8" Hose Barb Straight (Celcon)						
	20606100 1/2" Hose Barb Straight							
	20607100 1/4" Hose Barb Elbow							
	20608100 3/8" Hose Barb Elbow							
	21000231B* 1/4" John Guest (Polypro)							
	21000232B* 3/8" John Guest (Polypro)							

*21000231B and 21000232B are both 12 units per kit.

Stainless Steel Plastic

Dimensional Drawings

Inches (Millimeters)
Dimensional tolerances
± 0.06 inches
Consult factory if precise
details are required.

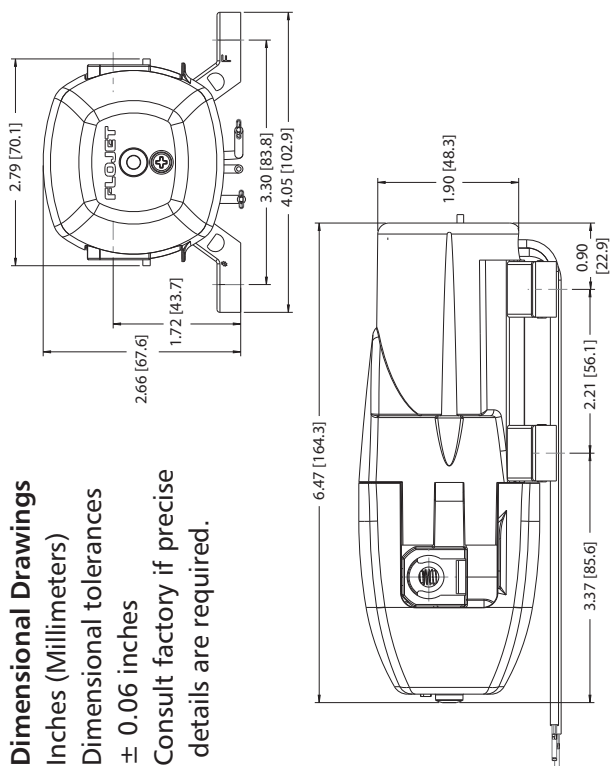

WARNING

EXPLOSION HAZARD



Only used with specified products. DO NOT PUMP LIQUIDS WITH A FLASH POINT BELOW 100°F (38°C) OR USE WHERE FLAMMABLE VAPORS ARE PRESENT.

FR À utiliser uniquement avec les produits spécifiés. NE PAS POMPER DE LIQUIDES DONT LE POINT D'ÉCLAIR EST INFÉRIEUR À 38°C (100°F) ET NE PAS UTILISER EN PRÉSENCE DE VAPEURS INFLAMMABLES.

DE Nur mit den angegebenen Produkten verwenden. KEINE FLÜSSIGKEITEN MIT EINEM FLAMMPUNKT UNTER 38 °C (100°F) PUMPEN UND NICHT IN GEGENWART ENTZÜNDLICHER DÄMPFE BENUTZEN.

IT Usare le pompa solo con i prodotti specificati. NON POMPARE LIQUIDI CON PUNTO DI INFIAMMABILITÀ MINORE DI 38°C NE USARE LA POMPA DOVE SONO PRESENTI VAPORI INFIAMMABILI.

NL Alleen gebruiken met aangegeven producten. POMP GEEN VLOEISTOFFEN MET EEN VLAMPUNT VAN MINDER DAN 38°C (100°F) EN GEBRUIK DE POMP NIET IN DE BUURT VAN BRANDBARE DAMPEN.

SE Använd endast med specificerade produkter. PUMPA INTE VÄTSKOR MED EN FLAMPUNKT UNDER 100 °F (38 °C) OCH ANVÄND INTE PUMPEN I NÄRHETEN AV BRANDFARLIGA ÅNGOR.

ES Usar sólo con productos específicos. NO BOMBEE LÍQUIDOS CON PUNTO DE INFLAMACIÓN INFERIOR A 38 °C (100 °F) NI USE LA BOMBA EN LUGARES DONDE EXISTEN VAPORES INFLAMABLES.

FLOJET

a xylem brand

www.xylemflowcontrol.com

UNITED STATES

East Coast
Tel: +1 978 281 0440 Fax: +1 978 283 2619

West Coast
Tel: +1 949 608 3900 Fax: +1 949 608 3887

UNITED KINGDOM

Tel: +44 (0) 1992 450 145 Fax: +44 (0) 1992 467 132

GERMANY

Tel: +49 (0) 40 53 53 73 0 Fax: +49 (0) 40 53 53 73 11

ITALY

Tel: +39 039 6852323 Fax: +39 039 666307

JAPAN

Tel: +81 (0) 45 475 8906 Fax: +81 (0) 45 477 1162

CHINA

Tel: (86)21 2208 2888 Fax: (86)21 2208 2999

LF Plus Series

FLOJET

a xylem brand

AUTOMATIC WATER SYSTEM PUMPS INSTALLATION GUIDE

FR Guide d'installation

DE Einbauanleitung

IT Guida all'installazione

NL Installatiegids

SE Installationsmanual

ES Guía de instalación



THE PRODUCT DESCRIBED HEREIN IS SUBJECT TO THE FLOJET ONE YEAR LIMITED WARRANTY, WHICH IS AVAILABLE FOR YOUR INSPECTION UPON REQUEST.

Flojet is a trademark of Xylem Inc. or one of its subsidiaries.
© Copyright 2012 Xylem Inc.

81000-230 Rev. B 11/2012

LF Plus Series

FLOJET
a xylem brand

AUTOMATIC WATER SYSTEM PUMP



ES

Serie LF Plus

Installation/Mounting

Remove shipping caps from pump ports. Some water from factory testing may spill out.

Mount pump vertically, with pump head down or horizontally in an accessible location. Do not compress feet with mounting screws.

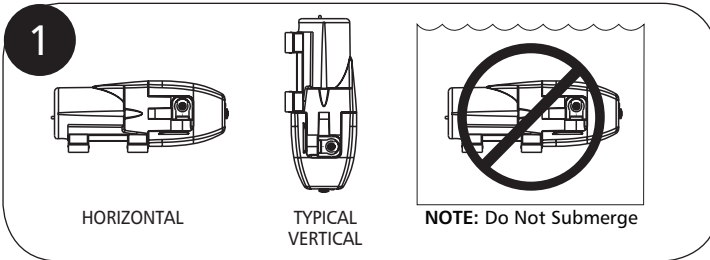

Plumbing

Use 3/8" I.D. flexible hose (preferably braided or reinforced). Use hose clamps on the slip-on hose barb connectors.

CAUTION Install a Flojet inlet 40 mesh strainer in an accessible location (for inspection and cleaning) between the tank and pump inlet. This strainer or equivalent is required for pup warranty to be valid.

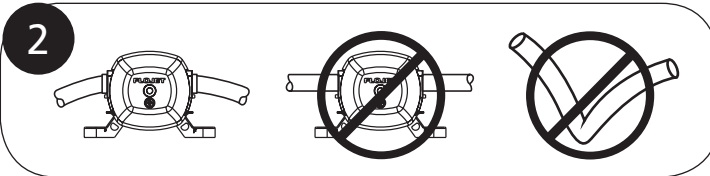

Electrical

In an easily accessible location, install a switch to control electricity to the pump. Turn the pump off when not in use for extended periods, when traveling or when tank is out of water.

A 4 amp. fuse should be installed in the positive line with the pump being its only load.

CAUTION Wire size based on total wire length, both positive and negative leads.

0-30 ft. #16 AWG
30-60 ft. #14 AWG
60-80 ft. #12 AWG

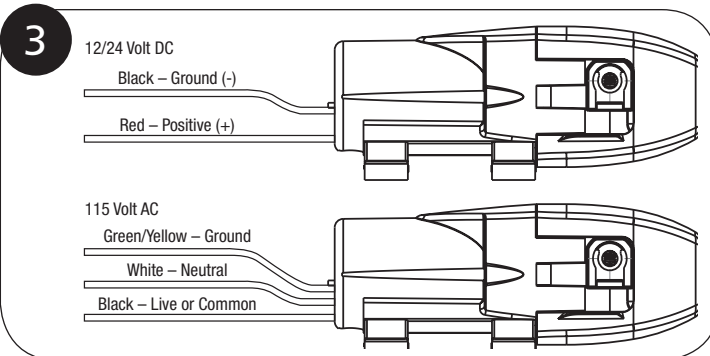

Operación

Las bombas Flojet serie LF Plus están disponibles como bombas a demanda automáticas o manuales. La LF Plus se encenderá automáticamente cuando se abra un dispositivo y se apagará cuando todos los dispositivos estén cerrados. La LF Plus es una bomba a demanda manual que se utiliza con un grifo eléctrico.

Al arrancar una bomba a demanda automática cuando el sistema está completamente seco, deje pasar tiempo hasta que la bomba llene el sistema. Abra un grifo, permita que circule el aire y ciérrelo cuando el flujo de agua sea parejo. Los filtros y aireadores deberían limpiarse regularmente.

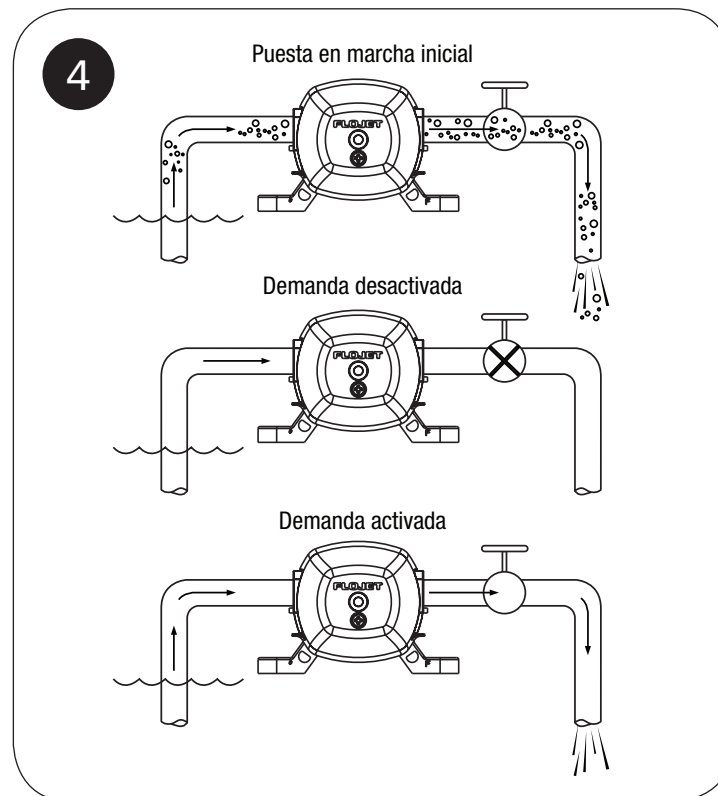

Filtros

Serie de la bomba	Número de filtro	Entrada	Salida	Filtro
LF Plus	1740-003	Tramo acanalado de 3/8	Tramo acanalado de 3/8	Malla 40

5

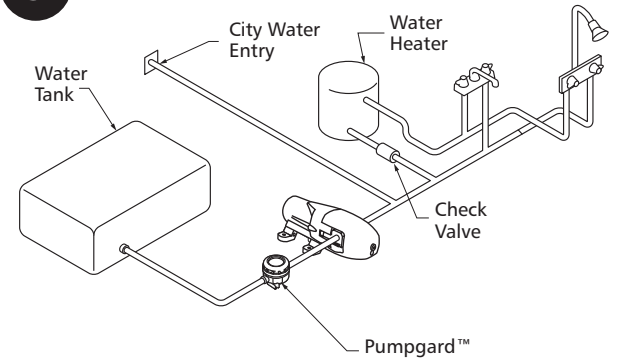

0.7 GPM Flow Curve

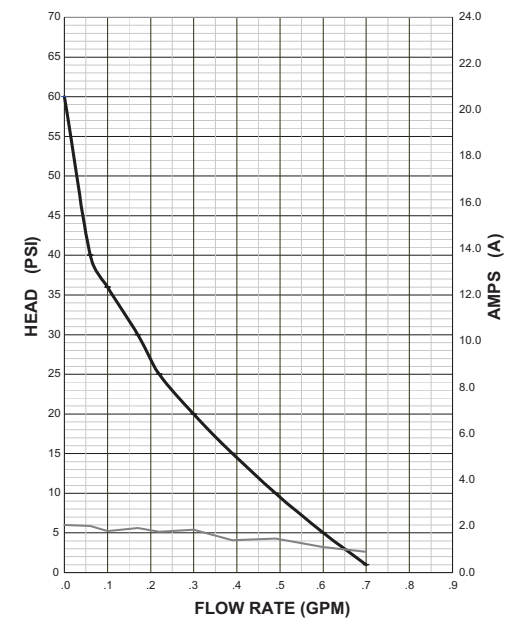

1.0 GPM Flow Curve

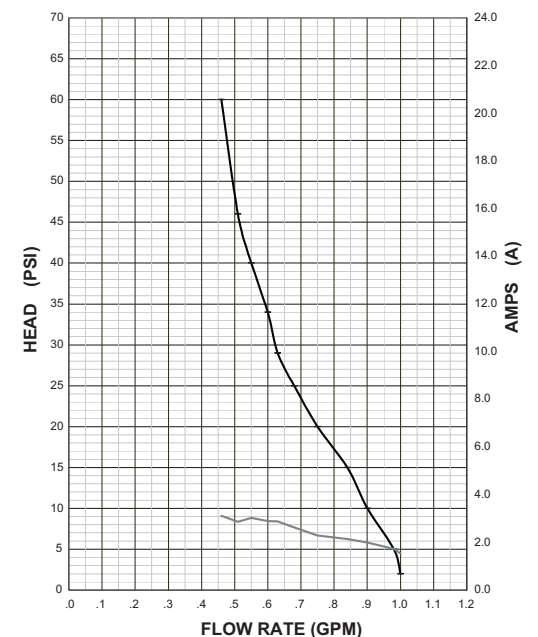



LF Plus Series

Operation

The Flojet LF Plus series pumps are available as automatic and manual demand pumps. The LF Plus will automatically turn on when a fixture is opened and turn off when all fixtures are closed. The LF Plus is a manual demand pump for use with an electric faucet.

When starting up an automatic demand pump with a completely dry system allow time for the demand pump to fill the system. Open a faucet, allow air to vent and close faucet when water flow is steady. Faucet strainers and aerators should be cleaned regularly.

	WARNING	
ELECTROCUTION HAZARD		
<p>To reduce the risk of electric shock, mount pump inside a fully enclosed area. Any other use not recommended by manufacturer may cause fire, electric shock, injury to person or death. Do not handle this pump unless power is disconnected. It is recommended that this unit be installed by a qualified electrician.</p>		

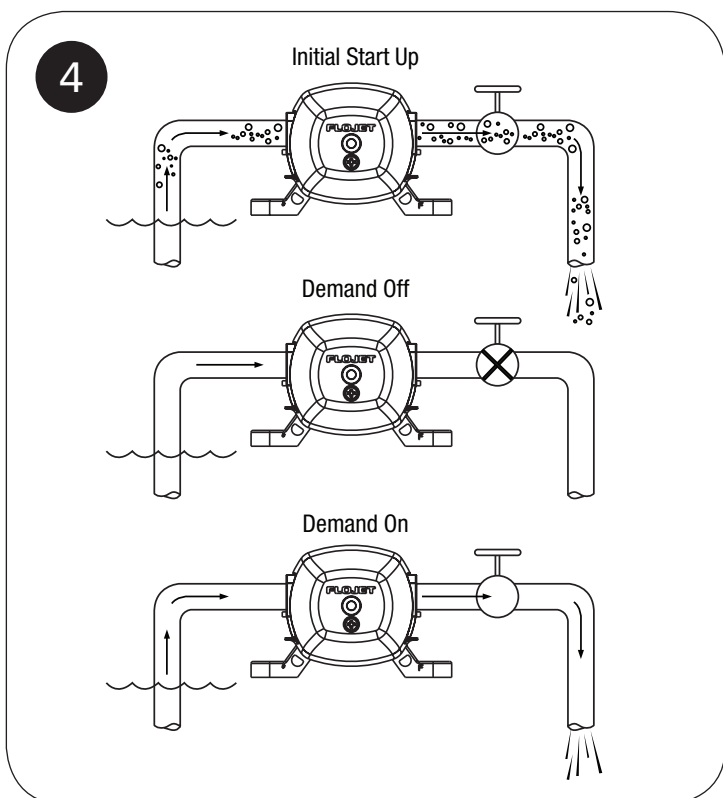

Strainers

Pump Series	Strainer Number	Inlet	Outlet	Screen
LF Plus	1740-003	3/8 Barb	3/8 Barb	40 Mesh

FLOJET

a xylem brand

**POMPE À
SYSTÈME D'EAU
AUTOMATIQUE****Installation/Fixation**

Retirer les bouchons d'expédition des embouts de pompe. Il est possible que de l'eau restant des essais usine se déverse.

Installer la pompe verticalement, la tête de pompe pointée vers le bas, ou horizontalement dans un endroit accessible. Ne pas écraser les pieds en serrant trop les vis de fixation.

1

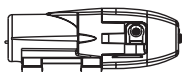

HORIZONTALE

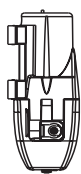
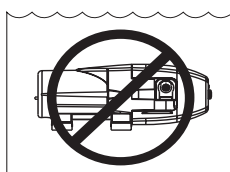
VERTICALE
TYPIQUE

N.B. : Ne pas submerger

Plomberie

Utiliser un tuyau souple de diamètre interne de 3/8 po. (9,5 mm) (de préférence tressé ou renforcé). Utiliser des colliers de serrage sur les connecteurs encliquetables à embout cannelé.

⚠ MISE EN GARDE

Installer un filtre en ligne d'arrivée d'eau de 420 microns (40 mesh) de Flojet, dans un endroit accessible (pour faciliter l'inspection et le nettoyage) entre le réservoir et l'arrivée de la pompe. Ce filtre ou un équivalent est requis pour assurer la validité de la garantie de la pompe.

2

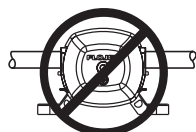
**Données électriques**

Dans un endroit facile d'accès, installer un interrupteur pour contrôler l'alimentation électrique de la pompe. Éteindre la pompe lorsqu'elle ne sert pas pendant de longues périodes, pendant les déplacements ou lorsque le réservoir est sorti de l'eau.

Un fusible de 4 A doit être installé sur la ligne positive, la pompe étant sa seule charge.

⚠ MISE EN GARDE

Taille de fil dépendant de la longueur totale des fils positif et négatif.

0-30 pi. (0-9 m) #16 AWG

30-60 pi. (9-18 m) #14 AWG

60-80 pi. (18-24 m) #12 AWG

3

12/24 V DC

Noir - Terre (-)

Rouge - Positif (+)

115 V AC

Vert/Jaune - Terre

Blanc - Neutre

Noir - Alimenté ou Commun

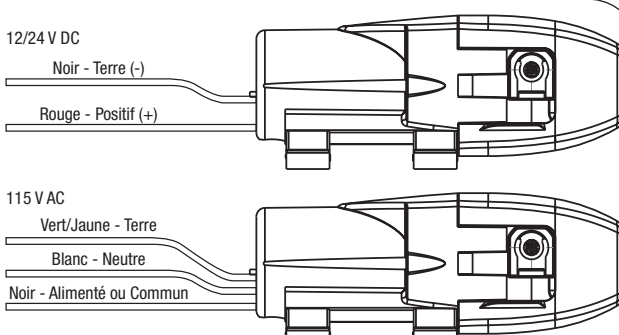



Série LF Plus

Fonctionnement

Les pompes Série LF Plus de Flojet sont disponibles sous forme de pompes de démarrage à la demande automatiques ou manuelles. La LF Plus se met en marche automatiquement dès qu'un robinet est ouvert et s'éteint de même lorsque tous les robinets sont fermés. La LF Plus est une pompe fonctionnant à la demande avec un robinet électrique.

Lors du lancement d'une pompe automatique avec démarrage à la demande dans un système entièrement à sec, laisser le temps à la pompe de remplir le système. Ouvrir un robinet, laisser l'air s'échapper et fermer le robinet lorsque le débit d'eau est régulier. Les crépines de robinet et les aérateurs doivent être nettoyés régulièrement.

	AVERTISSEMENT	
DANGER D'ÉLECTROCUTION		
<p>Pour réduire les risques de décharges électriques, installer la pompe dans un endroit entièrement clos. Toute autre utilisation non conseillée par le fabricant pourrait entraîner incendie, décharge électrique, blessure corporelle ou décès. Ne pas manipuler cette pompe sans auparavant déconnecter sa source d'alimentation électrique. Il est conseillé de retenir les services d'un électricien qualifié pour procéder à l'installation de cette unité.</p>		

4

Démarrage initial

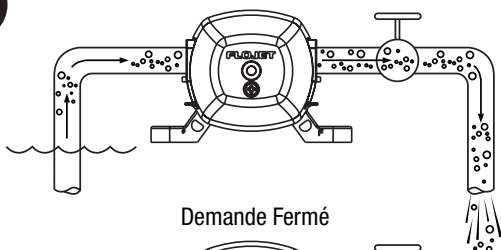

Demande Fermé

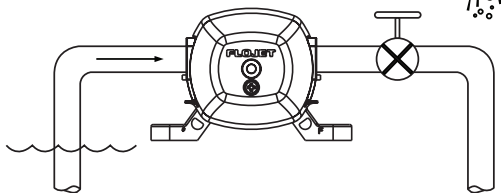

Demande Ouvert

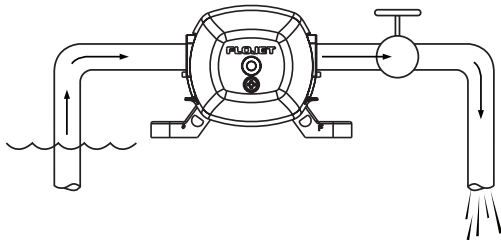

Filtres

Série de pompe	Numéro de filtre	Arrivée	Sortie	Crépine
LF Plus	1740-003	Embout de 3/8	Embout de 3/8	40 Mesh (420 µm)

FLOJET

a xylem brand

**AUTOMATISCHE
WASSERSYSTEM-
PUMPE****Installation/Einbau**

Transportstößel aus den Pumpenöffnungen entfernen. Dabei tritt evtl. etwas Wasser von der werkseitigen Prüfung aus.

Pumpe vertikal, mit dem Pumpenkopf nach unten, oder horizontal an einem zugänglichen Ort anbringen. Montagefüße nicht mit den Montageschrauben quetschen.

1

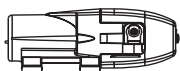

HORIZONTALMONTAGE

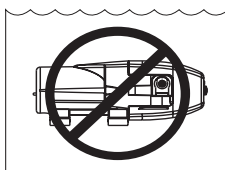
TYPISCHE
VERTIKALMONTAGE**HINWEIS:**
Nicht eintauchen**Leitungen**

Für den Anschluss einen flexiblen Schlauch mit 9,5 mm (3/8") Innendurchmesser (vorzugsweise Gewebe- oder armierten Schlauch) verwenden. Die aufsetzbaren Schlauchstutzen mit Schlauchklemmen befestigen.

⚠ VORSICHT

An einer (für die Prüfung und Reinigung) zugänglichen Stelle zwischen Tank und Pumpeneingang ein Flojet 40-Mesh-Sieb installieren. Ohne dieses Sieb oder eine entsprechende Vorrichtung verliert die Pumpengarantie ihre Gültigkeit.

2

**Elektroanschluss**

An einer zugänglichen Stelle einen Schalter zur Regelung der Stromzufuhr an die Pumpe installieren. Wenn die Pumpe längere Zeit nicht im Einsatz ist, Sie verreisen oder der Wassertank leer ist, die Pumpe ausschalten.

Eine 4-A-Sicherung sollte in der positiven Leitung installiert sein, wobei die Pumpe die einzige Strombelastung darstellt.

⚠ VORSICHT

Der Leiterquerschnitt basiert auf der Gesamtdrahtlänge der positiven und negativen Leiter.

0-9 m (0-13 ft.) #16 AWG

9-18 m (30-60 ft.) #14 AWG

18-24 m (60-80 ft.) #12 AWG

3

12/24 V Gleichstrom

Schwarz - Masse (-)

Rot - positiv (+)

115 V Wechselstrom

Grün/Gelb - Masse

Weiß - neutral

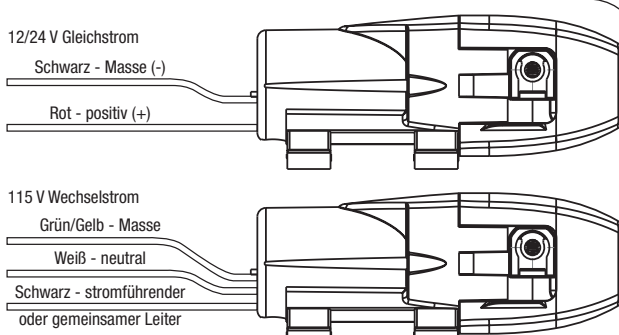
Schwarz - stromführender
oder gemeinsamer Leiter



Serie LF Plus

Betrieb

Die Flojet Pumpen der Serie LF Plus sind als automatische und manuelle Pumpensysteme erhältlich. Die LF Plus wird beim Öffnen eines Anschlusses automatisch eingeschaltet und ausgeschaltet, wenn alle Anschlüsse geschlossen werden. Die LF Plus ist eine manuelle, bedarfsgesteuerte Pumpe für den Einsatz mit einem Elektrozapfhahn.

Beim Starten einer automatischen bedarfsgesteuerten Pumpe im völlig trockenen Zustand dem System erst Zeit zum Auffüllen geben. Einen Zapfhahn öffnen, um die Luft entweichen zu lassen, und wieder schließen, wenn das Wasser gleichmäßig strömt. Zapfhahnsiebe und -belüfter regelmäßig reinigen.



WARNHINWEIS

STROMSCHLAGEGFAHR



Zur Vermeidung der Gefahr eines elektrischen Schlags die Pumpe in einem eingeschlossenen Bereich montieren. Jegliche vom Hersteller nicht empfohlene Einsatzmöglichkeiten können zu Brand, Stromschlag, Verletzungen oder Tod führen. Vor dem Umgang mit der Pumpe erst die Stromzufuhr trennen. Es empfiehlt sich, dieses Gerät von einem qualifizierten Elektriker installieren zu lassen.

4

Inbetriebnahme

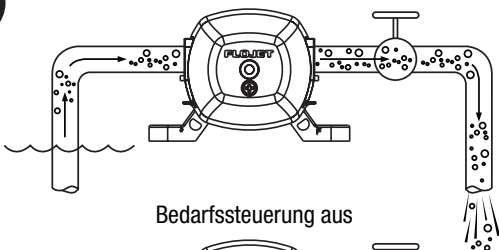

Bedarfssteuerung aus

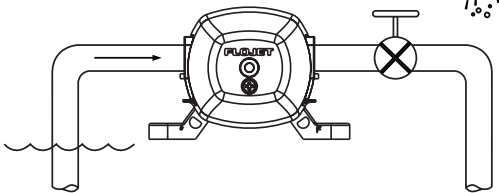

Bedarfssteuerung ein

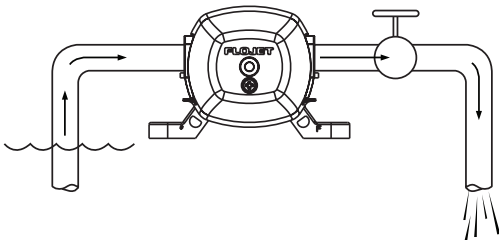

Siebe

Pumpenserie	Siebnummer	Einlass	Auslass	Filter
LF Plus	1740-003	3/8 Stutzen	3/8 Stutzen	40 Mesh

FLOJETa xylem brand
POMPA**AUTOMATICA
DELL'IMPIANTO
IDRICO****Installazione/Montaggio**

Rimuovere le coperture di spedizione dalle aperture della pompa. Potrebbe fuoriuscire un po' d'acqua rimasta dopo i test eseguiti dalla fabbrica.

Montare la pompa verticalmente, con la testa rivolta in basso oppure orizzontalmente in un luogo accessibile. Non comprimere i piedini con le viti di montaggio.

1

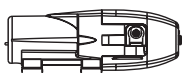

ORIZZONTALE

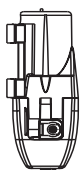
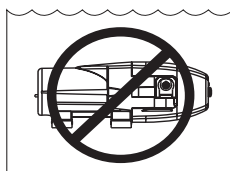
COMUNE
VERTICALE**NOTA:** non immergere**Collegamenti idraulici**

Usare tubo flessibile di 9,5 mm con diametro interno (preferibilmente intrecciato o rinforzato). Usare fascette fermatubo sui contatti sui connettori del giunto a gomito.

ATTENZIONE Installare una succhieruola d'ingresso Flojet a reticella 40 in una posizione accessibile (per l'ispezione e la pulizia) fra la tanica e l'ingresso della pompa. La succhieruola o filtro equivalente è necessaria per mantenere la validità della garanzia.

2

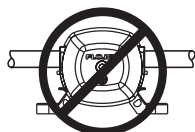
**Collegamenti elettrici**

In una posizione facilmente accessibile, installare un interruttore per controllare l'elettricità alla pompa. Spegnerla quando questa non verrà usata per lunghi periodi, durante un viaggio o quando nella tanica non c'è acqua.

Nella linea positiva, quando la pompa è l'unico carico su di essa, si dovrebbe installare un fusibile da 4 amper.

ATTENZIONE Dimensione dei fili basata sulla lunghezza totale dei fili; entrambi i fili conduttori, positivi e negativi.

0-9 m #16 AWG

9-18 m #14 AWG

18-24 m #12 AWG

3

CC 12/24 Volt

Nero - Terra (-)

Rosso - Positivo (+)

CA 115 Volt

Verde/Giallo - Terra

Bianco - Neutro

Nero - In tensione o comune

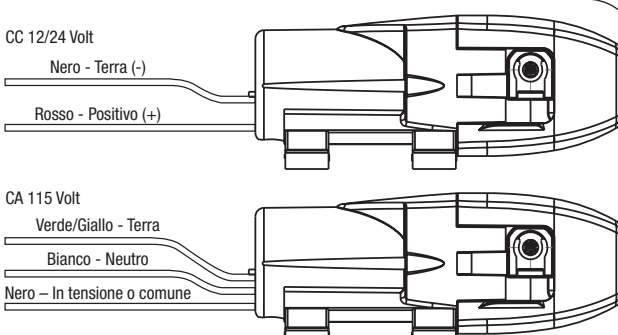



Serie LF Plus

Funzionamento

Le pompe Flojet Serie LF Plus sono disponibili come pompe a domanda manuale e automatiche. La pompa modello LF Plus si attiva automaticamente quando viene aperto un impianto e si disattiva quando tutti gli impianti sono chiusi. La pompa modello LF Plus è una pompa manuale a domanda da utilizzarsi con un rubinetto elettrico.

Quando si avvia una pompa a domanda automatica con un sistema completamente asciutto, attendere fino a quando la pompa a domanda riempie il sistema. Aprire un rubinetto, lasciare eliminare l'aria e chiudere il rubinetto quando il flusso dell'acqua risulta continuo. I filtri dei rubinetti e gli aeratori devono essere puliti con regolarità.





AVVERTENZA

PERICOLO DI ELETTROCUZIONE

Per ridurre il rischio di scossa elettrica, montare la pompa in uno spazio completamente racchiuso. Qualsiasi altro uso non raccomandato dal produttore può causare incendio, scossa elettrica, infortunio alla persona o la morte.
Non maneggiare questa pompa se la corrente non è disconnessa. Si raccomanda che l'installazione di questa unità sia fatta da un elettricista qualificato.

4

Avvio iniziale

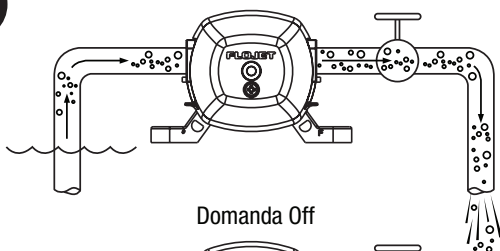

Domanda Off

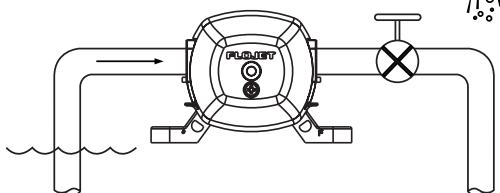

Domanda On

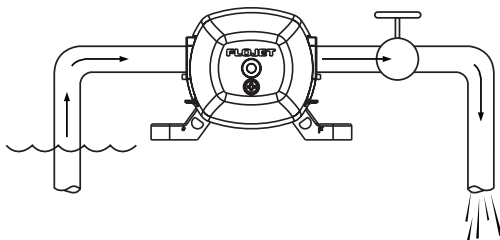

Succhieruole

Serie delle pompe	Numero della succhieruola	Ingresso	Uscita	Succhieruole
LF Plus	1740-003	Giunto a gomito 3/8	Giunto a gomito 3/8	Reticella 40

FLOJET

a xylem brand

**AUTOMATISCHE
WATERSYSTEEM-
POMP****Installatie/montage**

Haal de verpakkingdoppen uit de pomppoorten. Er kan een beetje water uitlekken van fabriekstesten.

Monteer de pomp verticaal op een goed bereikbare plaats en met de pompkop omlaag of horizontaal gericht. De poten niet samendrukken met de montageschroeven.

1

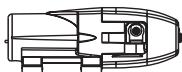

HORIZONTAAL

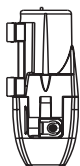
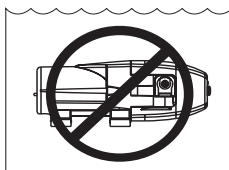
TYPISCH
VERTICAAL**OPMERKING:**
niet onderdompelen**Leidingsysteem**

Gebruik een flexibele slang (bij voorkeur omvlochten of versterkt) met een binnendiameter van 9,5 mm (3/8"). Bevestig de slangklemmen op de inschuifbare slangtules.

⚠ VOORZICHTIG

Monteer een Flojet 40-mesh zeef tussen de tank en de pompinlaat, op een plaats die goed bereikbaar is voor inspectie en reiniging. Zonder deze zeef of een gelijkwaardige voorziening is de garantie niet geldig.

2

**Elektrische gegevens**

Monteer op een goed bereikbare plaats een schakelaar voor de stroomvoorziening naar de pomp. Schakel de pomp uit als ze gedurende langere tijd niet wordt gebruikt, als ze wordt vervoerd of als er geen water meer in de tank zit.

Monteer in de positieve leiding een zekering van 4 amp die is voorbehouden voor de pomp.

⚠ VOORZICHTIG

De draadmaat is gebaseerd op de totale draadlengte (positieve en negatieve polen).

0-9 m (0-30 ft.) #16 AWG

9-18 m (30-60 ft.) #14 AWG

18-24 m (60-80 ft.) #12 AWG

3

12/24 Volt gelijkstroom

Zwart - aarde (-)

Rood - positief (+)

115 Volt wisselstroom

Groen/geel - aarde

Wit - neutraal

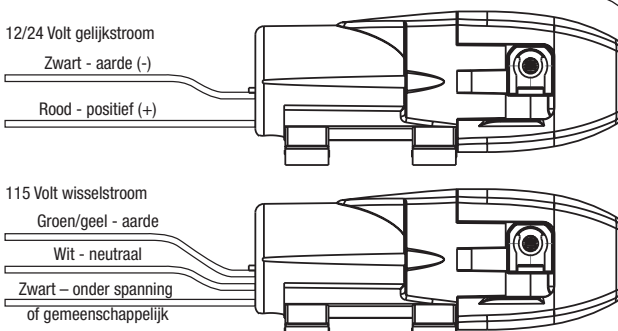
Zwart - onder spanning
of gemeenschappelijk



LF Plus Serie

Bediening

De Flojet LF Plus serie pompen zijn verkrijgbaar als automatische en handbediende zuigpompen. De LF Plus springt automatisch aan als een armatuur wordt geopend en uit als alle armaturen worden dichtgedraaid. De LF Plus is een handbediende zuigpomp voor gebruik met een elektrische kraan.

Als het systeem helemaal droog staat wanneer de automatische pomp wordt gestart, moet u de zuigpomp lang genoeg laten draaien om het systeem te vullen. Open een kraan, laat de lucht ontsnappen en sluit de kraan zodra er een constante stroom is. De kraanzeven en -ontluchters regelmatig reinigen.

	WAARSCHUWING	
GEVAAR VOOR ELEKTROCUTIE		
<p>Monteer de pomp in een volledig ingesloten ruimte om het risico van een elektrische schok te beperken. Elk ander gebruik dat niet door de fabrikant wordt aanbevolen, kan brand, elektrische schok, lichamelijk letsel of de dood veroorzaken. Deze pomp alleen hanteren als de stroom is uitgeschakeld. Aanbevolen wordt deze pomp door een vakbekwame electricien te laten installeren.</p>		

4

Allereerste inbedrijfstelling

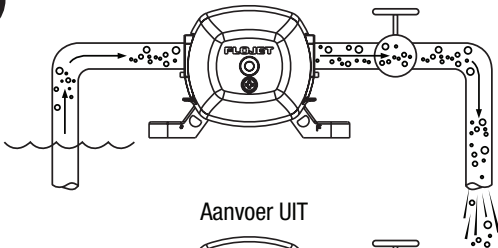

Aanvoer UIT

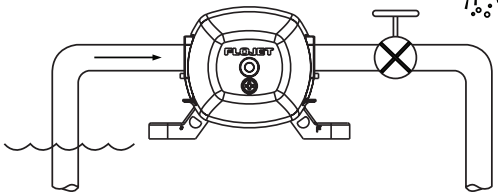

Aanvoer AAN

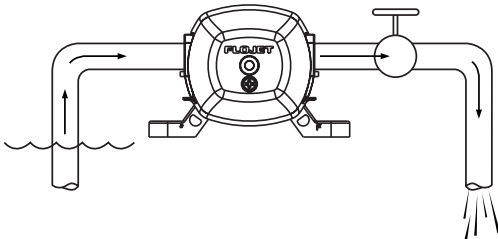

Zeven

Pompserie	Zeefnummer	Inlaat	Uitlaat	Zeef
LF Plus	1740-003	3/8 tule	3/8 tule	40 mesh

FLOJET

a xylem brand

**AUTOMATISK
VATTENSYSTEM-
PUMP****Installation/montering**

Avlägsna transportpluggar från pumpportar. En del vatten från fabrikstestning kan rinna ut.

Montera pumpen vertikalt, med pumphuvudet ned eller horisontellt på ett ställe med bra åtkomst. Tryck inte ihop fötterna med monteringskruvarna.

1

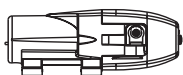

HORISONTELL

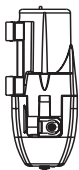
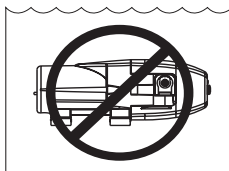
TYPISKT
VERTIKAL**OBS!**

Sänk inte ned i vatten

Rörledningar

Använd en flexibel slang med ID på 3/8" (9,5 mm) (helst omflätad eller förstärkt). Använd slangklämmor på den hullingförsedda, påskjutbara slangkopplingen.

⚠ VAR FÖRSIKTIG! Installera a Flojet sikt med minst 40-maskvidd på ett åtkomligt ställe (för inspektion och rengöring) mellan tanken och pumpintaget. Denna sikt eller motsvarande krävs för att pumpgarantin ska gälla.

2

**Elektriska komponenter**

Installera en brytare för att reglera elektriciteten till pumpen på ett lättåtkomligt ställe. Slå av pumpen när den inte ska användas under längre tid, när du reser eller när tanken inte är i vattnet.

En 4 A-säkring bör installeras i den positiva ledningen när pumpen är dess endast belastning.

⚠ VAR FÖRSIKTIG! Trådlängd baserad på total trådlängd, både positiva och negativa ledningar.

0-30 ft. (0-9 m) #16 AWG

30-60 ft. (9-18 m) #14 AWG

60-80 ft. (18-24 m) #12 AWG

3

12/24 V likström

Svart - jord (-)

Röd - positiv (+)

115 V växelström

Grön/gul - jord

Vit - noll

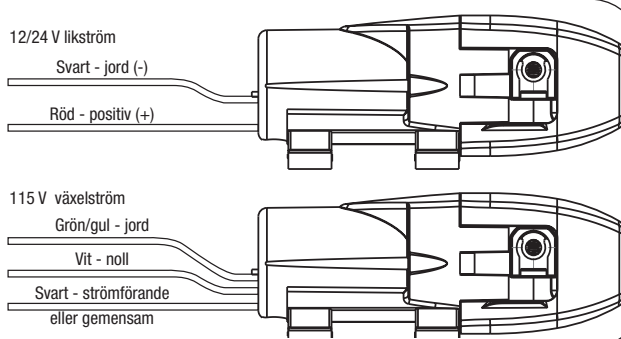
Svart - strömförande
eller gemensam



Serie LF Plus

Drift

Flojets pumpar i serien LF Plus är tillgängliga som automatiska eller manuella vid-behov-pumpar (on demand). LF Plus slås på automatiskt när en fixtur öppnas eller slås av när alla fixturer är stängda. LF Plus är en manuell vid-behov-pump för användning med en elektrisk kran.

När du startar en automatisk vid-behov-pump med ett fullständigt torrt system, ska du ge vid-behov-pumpen tid att fylla systemet. Öppna en kran, låt luft ventileras och stäng kranen när vattnet flödar jämnt. Kransiktar och avluftare bör rengöras regelbundet.



! VARNING!

RISK FÖR ELEKTRISK STÖT



För att minska risken för elektrisk stöt ska pumpen monteras inne på en helt inhägnad plats. Allt annat bruk som inte rekommenderas av tillverkaren kan orsaka brand, elektrisk stöt, personskada eller död. Hantera endast pumpen när den kopplats från strömförsörjningen. Vi rekommenderar att enheten installeras av en kvalificerad elektriker.

4

Första start

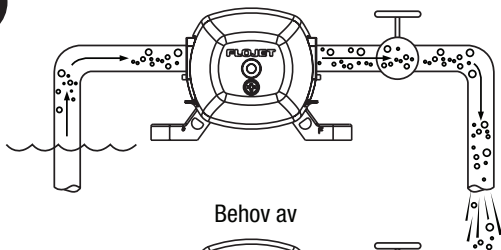

Behov av

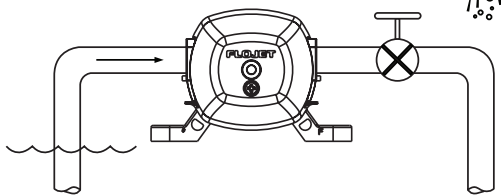

Behov på

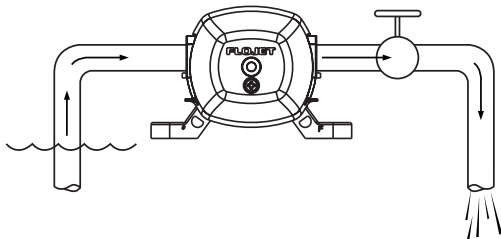

Siktar

Pumpserie	Siktnummer	Intag	Uttag	Silnät
LF Plus	1740-003	3/8 hulling	3/8 hulling	40-maskvidd

FLOJET

a xylem brand
**BOMBA DE
 SISTEMA
 AUTOMÁTICO
 DE AGUA**

Instalación/Montaje

Retire las tapas de transporte de las lumbreras de la bomba. Es posible que derrame un poco de agua de las pruebas en fábrica.

Monte la bomba verticalmente, con el cabezal de la bomba hacia abajo u horizontalmente en una ubicación accesible. No comprima las patas con los tornillos de montaje.

1

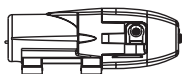

HORIZONTAL

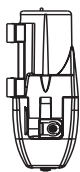
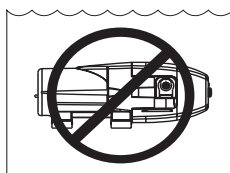
VERTICAL
TÍPICA**NOTA:** No sumergir**Tuberías**

Utilice una manguera flexible de 3/8" (9.5 mm) de D.I. (preferentemente trenzada o reforzada). Utilice abrazaderas en los conectores acanalados para manguera.

⚠ PRECAUCIÓN Instale un filtro de malla 40 de entrada Flojet en una ubicación accesible (para inspección y limpieza) entre el tanque y la entrada de la bomba. Este filtro o equivalente es necesario para que la garantía de la bomba sea válida.

2

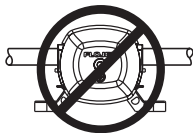
**Sistemas eléctricos**

Instale en una ubicación fácilmente accesible un interruptor para controlar la electricidad que llega a la bomba. Apague la bomba cuando ésta no es utilizada durante períodos prolongados de tiempo, mientras es transportada o cuando el tanque no tiene agua.

Debería instalarse un fusible de 4 amp. en la línea positiva con la bomba como su única carga.

⚠ PRECAUCIÓN El tamaño del cable se basa en la longitud total del cable, los polos negativos y positivos.

0-30 pies (0-9 m) #16 AWG

30-60 pies (9-18 m) #14 AWG

60-80 pies (18-24 m) #12 AWG

3

CD de 12/24 voltios

Negro - Tierra (-)

Rojo - Positivo (+)

CA de 115 voltios

Verde/Amarillo - Tierra

Blanco - Neutro

Negro - Vivo o común

